

67

COMPACT DISC
PLAYER

Q U A D

CONTENTS

	page
INTRODUCTION	2
GUARANTEE	2
SERVICE	2
ACCESSORIES SUPPLIED	3
INSTALLATION	3
POSITIONING THE CD PLAYER	4
CONNECTION TO THE AMPLIFIER	4
SWITCHING ON AND OFF	4
SIMPLE OPERATION DIRECT TO PLAY (without remote control)	4
FULL OPERATION WITH QUAD 67 REMOTE CONTROL	5
PROGRAMMING TRACKS	7
USING THE INDEX KEYS	8
PLAYER MAINTENANCE	9
DISC MAINTENANCE	9
SPECIFICATION	10
CONNECTING SOCKETS	12
CONTROLS AND DISPLAY INDICATIONS	12
FRONT AND REAR VIEW	15
REMOTE CONTROL LAYOUT	16
ACCESSORIES	inside back cover

**CLASS ONE
LASER PRODUCT**

INTRODUCTION

The Quad 67CD player is designed for the passionate music listener. It is simple to operate and has the minimum of controls. While it is anticipated that the majority of discs will be listened to from the beginning, tracks can be selected and played in any sequence. Random play (shuffle) is also provided.

The player disc drawer will accept compact audio discs in the 'normal' and 'CD single' format without any special adaptors.

The 67CD player is operated either by the Q66 remote control or the small hand held control supplied with the player.

Performance of the Quad 67CD player is as accurate as it is possible to achieve by careful design, choice of components and rigorous test procedures.

GUARANTEE

The Quad 67CD player is guaranteed against any defect in material and workmanship for a period of twelve months from the date of purchase. Within this period we will supply replacement parts free of charge. In the UK you have statutory rights which are not limited by this guarantee.

A separate guarantee card is not supplied and your guarantee begins on the day of purchase.

SERVICE

If servicing is required the 67CD player should be returned to the supplier, the distributor for the country of purchase or Quad Electroacoustics Ltd. Please enclose a brief note giving your name and address and the reason for returning the unit.

Quad offers a same-day service from Monday to Friday except for bank holidays. Please contact us to make an appointment.

How to Find us

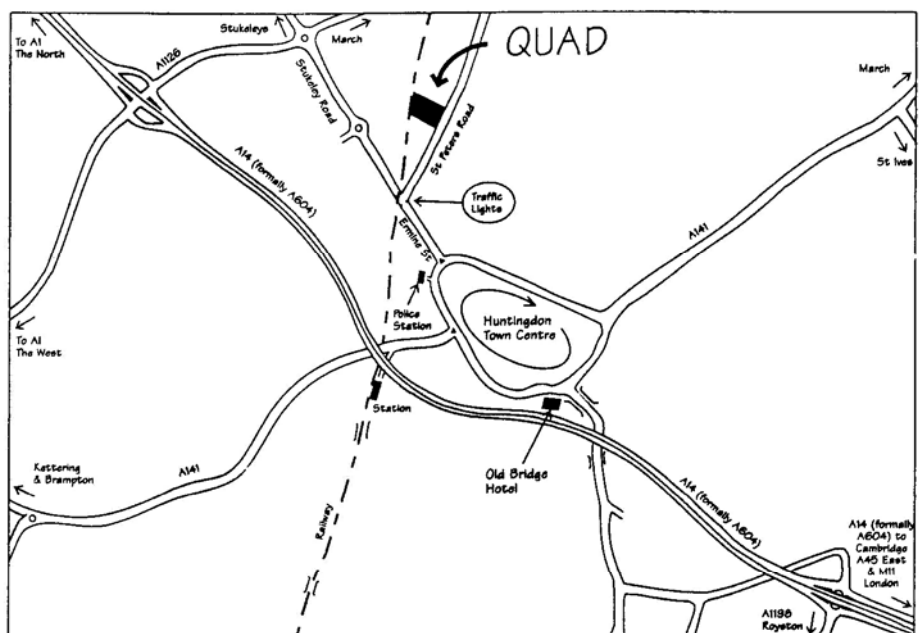

MAP2.CDR

**ACCESSORIES SUPPLIED
(UK versions only)**

AC power lead 1m Euro/Euro	Stock No. QSPES1A
AC power lead 2m with 13A 3 pin plug (13A fuse)	Stock No. QUKES2B
Signal lead 0.5m long	Stock No. QP2P2SA
Remote control (inc batteries)	Stock No. Q67REMA

Important

The original packing should be retained in case the player has to be returned for service.

INSTALLATION

Checking the AC Power Supply - The rating plate on the back of your player shows the AC supply voltage for which the player is set. If your AC supply is different from that indicated, ask your dealer or our Service Department to change the voltage setting for you.

Connecting to the AC Power Supply - The player is supplied with a 1m long AC supply lead already fitted with standard 3-pin Euro plugs for connection between the 67CD **AC power in** and the **AC power out** socket fitted on the back of current Quad equipment.

For connection direct to the mains supply then the supplied lead already fitted with a 13A 3 pin plug should be used. Do not cut off this plug or use it with its fuse cover removed. If however for any reason the plug has to be removed then it must be disposed of and **under no circumstances** plugged into a 13A socket outlet. A suitable plug can be fitted, as explained below:-

WARNING: THIS APPARATUS MUST BE EARTHED

IMPORTANT - Fitting a mains plug.
The wires in the mains lead are coloured:

Brown = Live Blue = Neutral Green/Yellow = Earth

The **Brown** wire must be connected to the terminal marked **L** or coloured **Red**.
The **Blue** wire must be connected to the terminal marked **N** or coloured **Black**.
The **Green/Yellow** wire must be connected to the terminal marked **E** or coloured **Green/Yellow**.

Note

When a fused 13A plug is used a 13A fuse (ASTA approved to BS1362) can be used. For other types of plug, then fit a suitable fuse either in the plug or adaptor, or at the distribution board. If in doubt consult a qualified electrician.

POSITIONING THE CD PLAYER

The CD Player can be positioned free-standing or stacked with other components. Never place the player in persistent direct sunlight or near any heat source.

Free Standing - If free standing the player must always be placed horizontally on a flat firm surface and not subjected to excessive vibration.

Stacked - If the player is stacked on top of other equipment, it should not stand directly on top of a high power amplifier as such amplifiers generate a substantial amount of heat.

CONNECTION TO THE AMPLIFIER

At the back of the player you will find the **audio output** sockets for the connecting lead to the preamplifier. Insert the **white** plug of the audio connecting lead supplied to the **L** socket (white = left channel) and the **red** plug to the **R** socket (red = right channel).

Insert both the plugs, at the other end of the lead, into the corresponding **CD** or **AUX** sockets of your amplifier system.

If necessary, you can use the **TUNER** or **TAPE IN** sockets, but never the **DISC/PHONO/PICK-UP** sockets which are totally unsuitable for CD players.

SWITCHING ON AND OFF

Press the **ON/OFF** button. This has a sequential action so pressing it again will switch the player off.

As soon as the player is switched on, with the disc drawer empty, the display shows '**67CD**' briefly followed by '- - - -'.

SIMPLE OPERATION DIRECT TO PLAY (without remote control)

Loading a Disc - Open the disc drawer by pressing the **DRAWER OPEN/CLOSE** flap. Carefully place the disc, label side up, in the centre of the drawer compartment.

Close the drawer by pushing it gently. It will then close by itself and after a short pause start to play the whole disc starting from the beginning.

Whilst the disc is playing the display will show the track number and count down the playing time for the track being played, plus any index details present on the disc.

Unloading a Disc - Press the **DRAWER OPEN/CLOSE** flap. The disc will stop playing and the drawer will open. Remove the disc carefully and return it to its container. To close the drawer push it gently or press the **DRAWER OPEN/CLOSE** flap again. It will close by itself.

To keep out dust which could fall on the laser pick-up do not leave the drawer open unnecessarily.

Note If '**ERROR**' appears for approx 3 seconds after the drawer closes, followed by '- - - -', it means you have either loaded the disc upside down or it is otherwise unacceptable (dirty, badly scratched or defective in some way), you have loaded a CD ROM or similar incompatible format or you have not loaded a disc at all.

FULL OPERATION WITH QUAD 67 REMOTE CONTROL

Loading a Disc - Open the disc drawer by pressing the **DRAWER OPEN/CLOSE** flap. Carefully place the disc, label side up, in the centre of the drawer compartment.

Close the drawer by pressing the **DRAWER OPEN/CLOSE** flap. After a short pause, while the laser pick-up scans the disc, the display will show the number of tracks on the disc and the total playing time.

Note that the disc drawer can also be opened and closed via the 67 remote control with the **DRAWER OPEN/CLOSE** key.

Playing a Complete Disc - If you simply want to play the complete disc you can press **PLAY** as soon as the disc data is displayed. Once the laser pick-up reaches the beginning of the first track, '1' will appear in the display and at the same time the playing time will be shown, in minutes and seconds. This will count down in seconds as the disc is played.

As each track ends the track number changes to the next track being played, and the playing time changes to that of the new track being played.

As soon as all the tracks have been played the disc will stop and the display will show the total number of tracks and the total playing time.

Pausing During Play - For short interruptions press **PAUSE**; 'PAUSE' will appear in the display. To restart press **PAUSE** again and play will start from the exact point where it was interrupted.

Going Back to the Beginning of a Track - To go back to the beginning of the track being played, briefly press **PLAY**. The track then starts again from the beginning.

Moving to Another Track - At any time during play you can choose another track. This can be a later or an earlier track. Just select the required track number, using the numeric keypad, and after a short pause the track will be played.

Alternatively you can skip tracks by pressing the appropriate **TRACK** ← → key until the desired track number is shown in the display, as explained below.

Selecting a Later Track - Press **TRACK** → until the desired track number is displayed. Should you press **TRACK** → whilst the last track is playing this will have no effect.

You can also use **TRACK** → to preview a disc by listening to the beginning of each track.

Selecting a Previous Track - Press **TRACK** ← until the desired track number is displayed.

Should you press **TRACK** ← whilst the first track is playing this will have no effect and the track will carry on playing.

Note

Each time you press a **TRACK** key the player will skip one track at a time. If you keep the key depressed it will keep skipping tracks until the key is released.

Beginning at a Specific Track - Instead of the first track you can start play from any other track. In this case you wait until the contents of the disc have been read. The total number of tracks is then shown with the total disc playing time. Bring the number of the required track into the display using either the numeric keypad or the **TRACK** ← → keys. Then start play by pressing **PLAY**. You can also change tracks during play.

Finding a Particular Passage on a Disc - During play you can quickly find a particular passage in a track by pressing, and holding down, one of the **SEARCH** ← → keys.

While you hold down **SEARCH** ← the laser pick-up runs back towards the beginning, and while you hold down **SEARCH** → the laser pick-up runs towards the end of the disc.

By alternating between these keys you can locate any particular part or passage. As soon as you release a key, play starts at once.

If you continue to hold down the key during search, the disc will play at successively faster speeds; for the first few seconds slightly faster than normal, then at a higher speed.

The sound can still be heard, though speeded up, to act as an aid to searching. You can, of course, search with the aid of the playing time display.

Should you, by pressing **SEARCH** ←, take the laser pick-up to the beginning of the first track the first 5 seconds approx will be repeated and playback resumes as soon as you release the key.

Should you, by pressing **SEARCH** →, take the laser pick-up to the end of the last track the disc will stop playing and the display will show the total number of tracks and total playing time.

To Stop Play - To stop play before the end of a disc press **STOP**. The display will then show the total number of tracks on the disc and the total playing time. If you want to stop play and also remove the disc, without using the remote control then just press the **DRAWER OPEN/CLOSE** flap on the CD player. The disc will immediately stop playing and the drawer will open. Do not forget to close the drawer after you remove the disc.

Random Play - You can play the tracks on a disc in a completely random sequence by pressing the **RANDOM** key. Play will start as soon as this key is depressed and '**SHUF**' will be displayed for a few seconds followed by the details of the track being played. Pressing **STOP** will cancel the random play function.

Pressing either of the **TRACK** keys will step through the random sequence but if you want to start from the beginning, of the random sequence, keep pressing **TRACK** ← until it has no further effect.

Play can be stopped and started for short periods, if required, by using the **PAUSE** key.

PROGRAMMING TRACKS

Instead of playing a complete disc, you can choose a number of tracks and play only these in whatever sequence you decide. You can store the same track more than once. It is also possible to enter a group of tracks such as 1 to 4, 6 to 9, or 5 to 2, to speed up programming when consecutive tracks are to be played or to allow for very long playing periods.

Programming is only possible when a disc is in the player and its contents have been read to determine the highest track number that can be chosen.

To store the track numbers that you want to play (these can be found from the contents list supplied with the disc), bring up each required track number in turn to the display, using either the numeric keypad or the **TRACK** ← → keys and then put it in the player's memory by pressing **STORE**. Whilst entering tracks the display will show the total playing time of all the tracks which have been stored.

Up to 50 tracks/programmes can be stored but if the total playing time exceeds that which can be displayed '99.59' the display will show '0000'. Further tracks/programmes can still be entered although the time will not be displayed. When 50 tracks have been entered 'End' will be displayed.

During programmed play all the player controls remain operative except for **SEARCH** ← which will only search back to the beginning of the actual track being played.

Example 1

From a disc containing 12 tracks you want to play tracks 9, 5, 1 and 11 in that order. Load the disc and close the drawer with the **DRAWER OPEN/CLOSE** flap or the 67 remote control **DRAWER OPEN/CLOSE** key. When the disc content has been read the display will show '12', and the total disc playing time.

Now bring '9' into the display, using either the numeric keypad or the **TRACK** ← → keys, and then press **STORE**. A 'P' (for Programme) will appear above **INDEX** to show that the track has been stored. The display will show '9 P' and the playing time of track 9.

Now go to track '5' and press **STORE** again. The display will now show '5 P' and the combined playing time of tracks 9 and 5.

Continue choosing the other tracks in the same way and storing them with the **STORE** key. As soon as you have stored the last track number the display will show '11 P' and the total playing time for all the tracks stored (eg, tracks 9+5+1+11). This will remain until you start play, by pressing **PLAY**. The first selected track will then be displayed with its playing time.

Example 2

From a disc containing 12 tracks you want to play tracks 9, and then the group 5 to 11 in that order. Load the disc and close the drawer with the **DRAWER OPEN/CLOSE** flap or the 67 remote control **DRAWER OPEN/CLOSE** key. When the disc contents have been read the display will show '12', and the total disc playing time.

Bring '9' into the display, using either the numeric keypad or the **TRACK** ← → keys, and press **STORE**. A 'P' (for Programme) will appear above **INDEX** to show that the track has been stored. The display will show '9 P' and the playing time of track 9.

Now go to track '5' and press **STORE** again. The display will show '5 P' and the combined playing time of tracks 9 and 5. Now select track '11' the display will show '11'. Now press **SEARCH** →, a '0' will appear above **INDEX** to show that the player is in the group mode and the playing time will change to show the total of all the tracks stored so far. Press **STORE** and the display will show '11 P' This will remain until you start play, by pressing **PLAY**. The first selected track will then be displayed with its playing time.

Note If after pressing **SEARCH** → you decide that you do not want to group tracks just press **SEARCH** ← to cancel this function, before pressing **STORE**.

Checking the Memory Contents - During play you can check the contents of the memory by pressing the **TRACK** → key to step through the selected track numbers in the programmed sequence. In our example; '9 - 5 - 1 - 11'. After checking do not forget to step back to the beginning of the sequence using the **TRACK** ← key or pressing **STOP** (do not press **STOP** more than once as this will clear the programming).

To Erase the Whole Programme Memory - You can clear a programme at any time by opening the disc drawer. Pressing **STOP** will also clear the programme but if the disc is playing **STOP** has to be pressed twice, once to stop play and once to clear the programme.

To Start Play - Press **PLAY**. The track number of the first programmed selection will be displayed and this will change, as each selected track is played, so that the progress of play can be followed. You can check the tracks still to be played, at any time, by pressing the **TRACK** ← → keys.

You can return to the beginning of a programmed track, or to the previously programmed track by pressing **TRACK** ←. If you want to go on to a following programmed track press **TRACK** →. You can also search for a particular passage using the **SEARCH** ← → keys but **SEARCH** ← is limited to the track currently being played. To hold play at any time during a programme press **PAUSE**. Pressing **PAUSE** again will restart play.

When all the tracks have been played the disc stops. However, the current programme is still retained in the memory for one further operation so pressing **PLAY** again will repeat the sequence. To erase the programme open the drawer compartment or press **STOP**.

USING THE INDEX KEYS

These are used for selecting a specific part of a track on discs recorded with index numbers and up to 99 can be selected per track. This facility is only usable on certain discs containing index information and this will be detailed in the disc content instructions supplied with the disc.

The required index number can be entered in both play and standby modes. Should you select an index for a disc not incorporating this facility 'ERROR' will appear briefly.

Selecting a Track Index - First decide which track and index numbers you want from the information supplied with the disc. Select the track and then use the **INDEX** ← → keys to show the required number in the display. Press **INDEX** → to step to higher numbers and **INDEX** ← to step down to lower numbers. If either key is held down stepping will continue until the key is released.

During play, after a short pause, the chosen track index will be automatically selected. From the stop mode the chosen track index will be selected as soon as **PLAY** is pressed.

PLAYER MAINTENANCE

The player mechanism is provided with self-lubricating bearings and no routine maintenance is required.

If necessary the case can be cleaned with a soft brush or, for more stubborn marks, a slightly moistened lint-free cloth. In this event remove the mains plug from the supply socket. Do not use cleaning agents, solvents or abrasives.

The disc compartment should be kept free from dust.

Remote Control Battery Replacement - In normal use the batteries fitted should last for approximately one year. Low batteries will cause erratic operation and reduce the operating range.

To replace the batteries turn the unit upside down and clip off the battery compartment lid (insert thumbnail into wider slot, press and lift up lid).

Insert the new batteries carefully, ensuring polarity is as shown in the battery compartment, and refit the battery compartment lid. The control is now ready for operation.

Always use leakproof batteries (two AAA size alkaline cells) and never mix battery types or re-use old batteries.

DISC MAINTENANCE

Although the music tracks on a compact disc are covered with a protective layer, it is still advisable to handle a disc carefully. As long as you always pick up discs by the edge and put them back in their protective holders immediately after use, cleaning will not normally be necessary.

However, should fingerprints, dust or dirty marks appear on a disc you can wipe them off with a soft lint free cloth. Always wipe the disc in straight lines from the centre to the outer edge.

If necessary you can breathe on the disc first but detergents, abrasive cleaning agents or cleaning materials for conventional records must not be used!

Never write on the disc label; this can cause irreparable damage to the music tracks.

Main Unit	Operation:	Full function by infrared remote control or simple direct to play operation without remote control
	Number of channels:	2
	Frequency response:	< ± 0.1 dB 20 - 20,000 Hz
	Phase linearity:	< ± 0.5° 20 - 20,000 Hz
	Signal/noise ratio:	>100 dB 20 - 20,000 Hz
	Crosstalk:	>100 dB at 1 kHz
	Total harmonic distortion:	< 0.002% at 1 kHz
	Wow and flutter:	Below measurement levels
	D/A conversion:	18 Bit 64x oversampling. Delta - Sigma convertor
	Error correction system:	Cross Interleaved Reed Solomon Code (CIRC)
	Audio output:	2 V rms max. 300 mV on normal programme material. Minimum load impedance 10 kΩ
	Optical readout system:	Laser semi-conductor AlGaAs wavelength 800 nm
	Sampling frequency:	44.1 kHz
	Digital output:	For digital signal processors
	Remote control Interface:	RC-5 system
	Mains voltage:	110-120V, 220-240V (changed by links on PCB) 50 - 60 Hz: see rating plate on player back
	Fuse (HRC):	220-240V T125 mA: 110-120V T250 mA
	Power consumption:	14W approx.
	Dimensions:	Width 321 mm; height 80 mm; depth 240 mm approx. (less connectors) drawer opens by 145 mm approx.
	Weight:	3.5 kg approx.

Remote Control	System:	Infrared
	Dimensions:	Width 55 mm; length 175 mm; thickness 22 mm approx.
	Weight:	90g (inc batteries) approx.
	Battery life:	One year approximately with normal operation, using alkaline cells
	Battery type:	Two AAA size alkaline cells

Disc Specification

Diameter:	120 mm and 80 mm
Thickness:	1.2 mm
Direction of rotation:	Anti-clockwise (seen from reading side)
Scanning velocity:	1.2 - 1.4 m/s
Rotation speed:	500 - 200 rpm
Stereo playing time:	74 minutes max. (theoretical)
Track pitch:	1.6 μ m
Material:	Plastic

The right is reserved to alter performance and specifications as required.

This compact disc player complies with the radio interference requirements as laid down in EEC (European Economic Community) regulations.

CONNECTING SOCKETS

AUDIO OUTPUT L/R:	Audio output for connection to the CD input of an amplifier.
DIGITAL OUT:	Digital output for future CD applications such as digital signal processing.
AC POWER IN:	For the AC power supply input lead.
DC POWER SUPPLY:	Optional DC supply for 66 control panel supplied with 66 preamplifier.

CONTROLS AND DISPLAY INDICATIONS

Your Quad compact disc player is very easy to operate but to assist you the operating controls and display indications are described below. The following terms for the keys etc. are used throughout the text.

Player Controls

ON/OFF Button:	For switching the player mains on and off.
DRAWER Flap:	To open and close the disc loading drawer.

Remote Control Keys

OPEN/CLOSE:	To open and close the disc loading drawer.
PLAY:	For starting play.
PAUSE:	To interrupt play for short periods. Press to pause, press again to start.
STOP:	For stopping play and for erasing programmes (operating twice clears memory).
RANDOM:	For playing all the tracks on a disc in a random order (shuffle).
STORE:	For storing track numbers in the memory when programming. Up to 50 tracks/programmes can be stored.
TRACK ← →:	For skipping tracks during play and selecting tracks when programming.
0 - 9:	For choosing a track during play and when programming.
SEARCH ← →:	For fast search of a particular passage in a track during play. When programming SEARCH → selects group mode, SEARCH ← cancels group mode.
INDEX ← →:	For selecting a particular index in a track (only on discs with index markings).

DISPLAY INDICATIONS

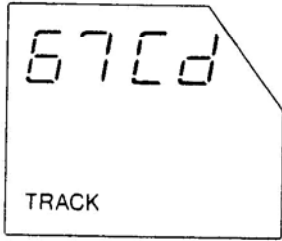

ON - As soon as the player is switched on, with the disc drawer empty, the display shows '67CD' briefly and then '- - -' appears continuously (see **STANDBY** below). If a disc is in the drawer then after '67CD' the display shows the disc contents (see **PLAYING TIME** below).

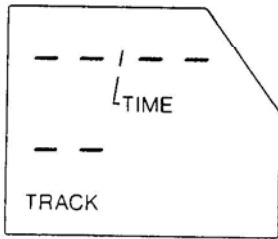

STANDBY - The display shows '- - -' when there is no disc in the player and when the drawer is opening and closing.

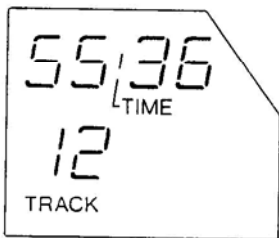

PLAYING TIME - When the contents of a disc have been read the highest track number is indicated together with the total playing time in minutes and seconds.

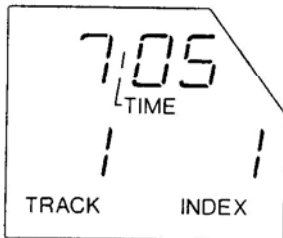

PLAY - As soon as play starts the track number and playing time is indicated.

PLAYING INFORMATION - During play the playing time of the track is indicated in minutes and seconds. This will count down as the track is being played.

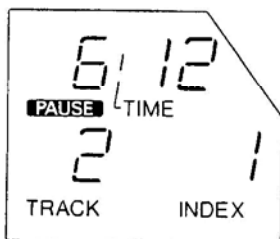

PAUSE - When play is interrupted 'PAUSE' appears. This disappears as soon as play is resumed.

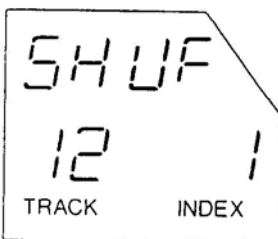

RANDOM PLAY - When random play is selected 'SHUF' is displayed briefly, followed by the first track being played and its playing time.

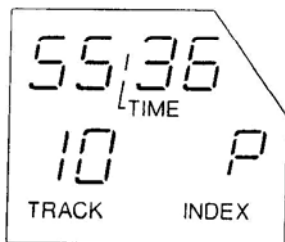

PROGRAMMING - When tracks are stored during programming a '**P**' is displayed after the track number. Also the total additive playing time of all the selected tracks.

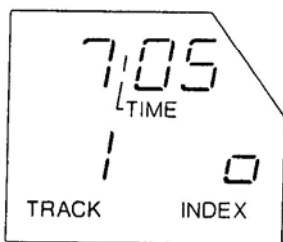

PROGRAMMING - '0' is displayed above **INDEX** when **SEARCH** → is pressed for entering a series of numbers when a programme of consecutive tracks needs to be stored.

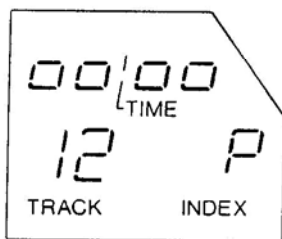

PROGRAMMING - When the total time of stored tracks exceeds 99m 59s '**0000**' is displayed. Further tracks can still be stored.

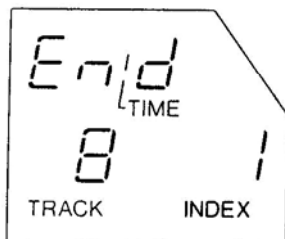

PROGRAMMING - '**End**' is displayed when you try to store more than 50 tracks/programmes.

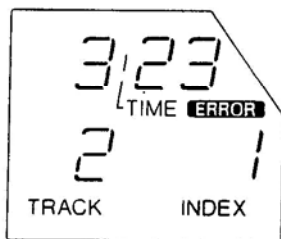

ERROR - '**ERROR**' appears briefly during initial switch on when you make an operating mistake.

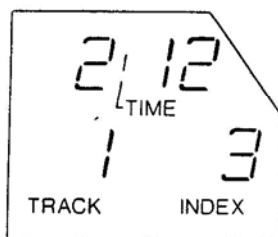

INDEX - Displays a selected index number. Also displays the index numbers as a track is being played. For discs without indexing this will always be '1'.

FRONT VIEW

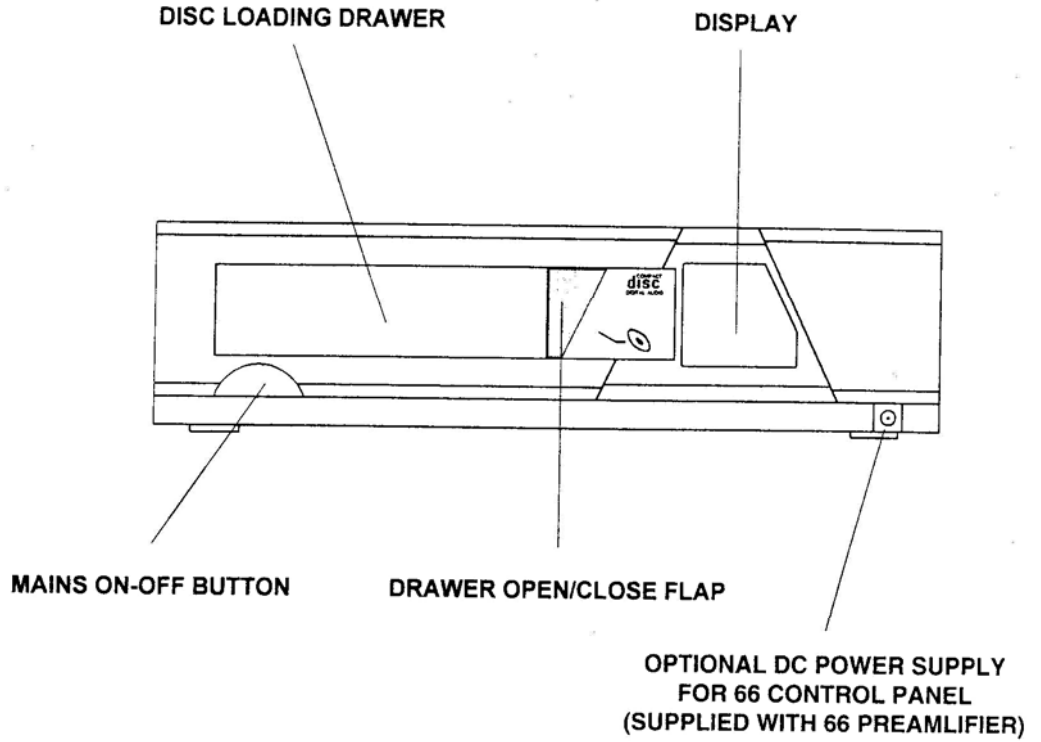

REAR VIEW

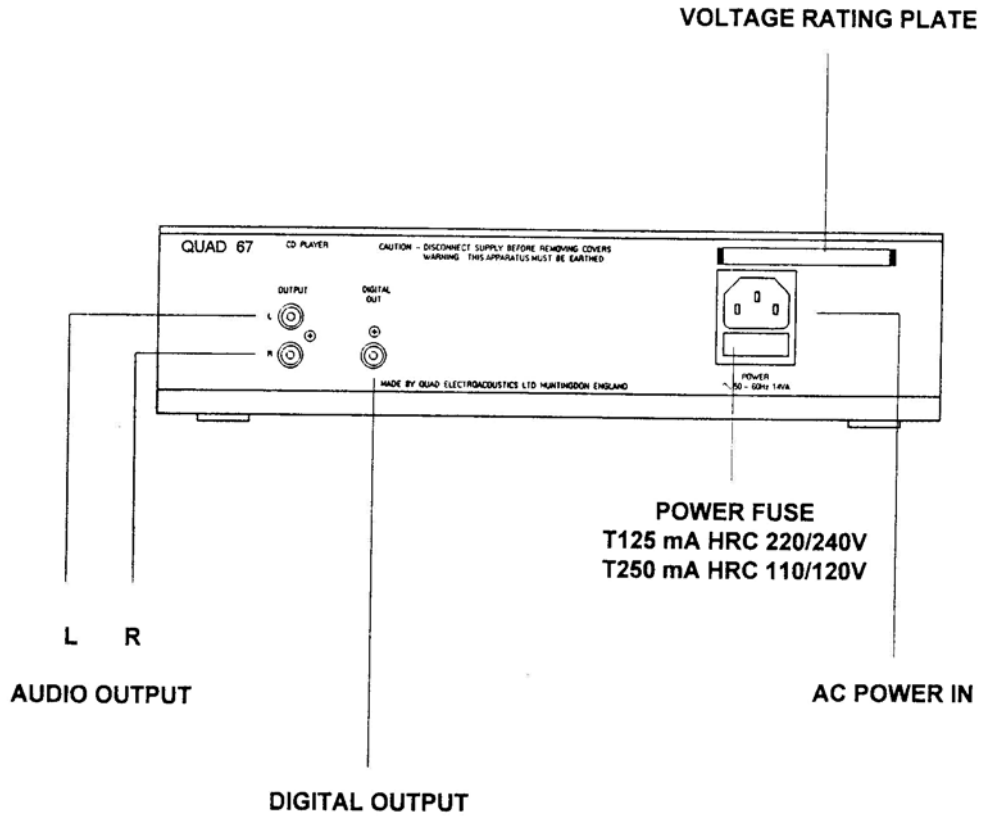

REMOTE CONTROL
LAYOUT

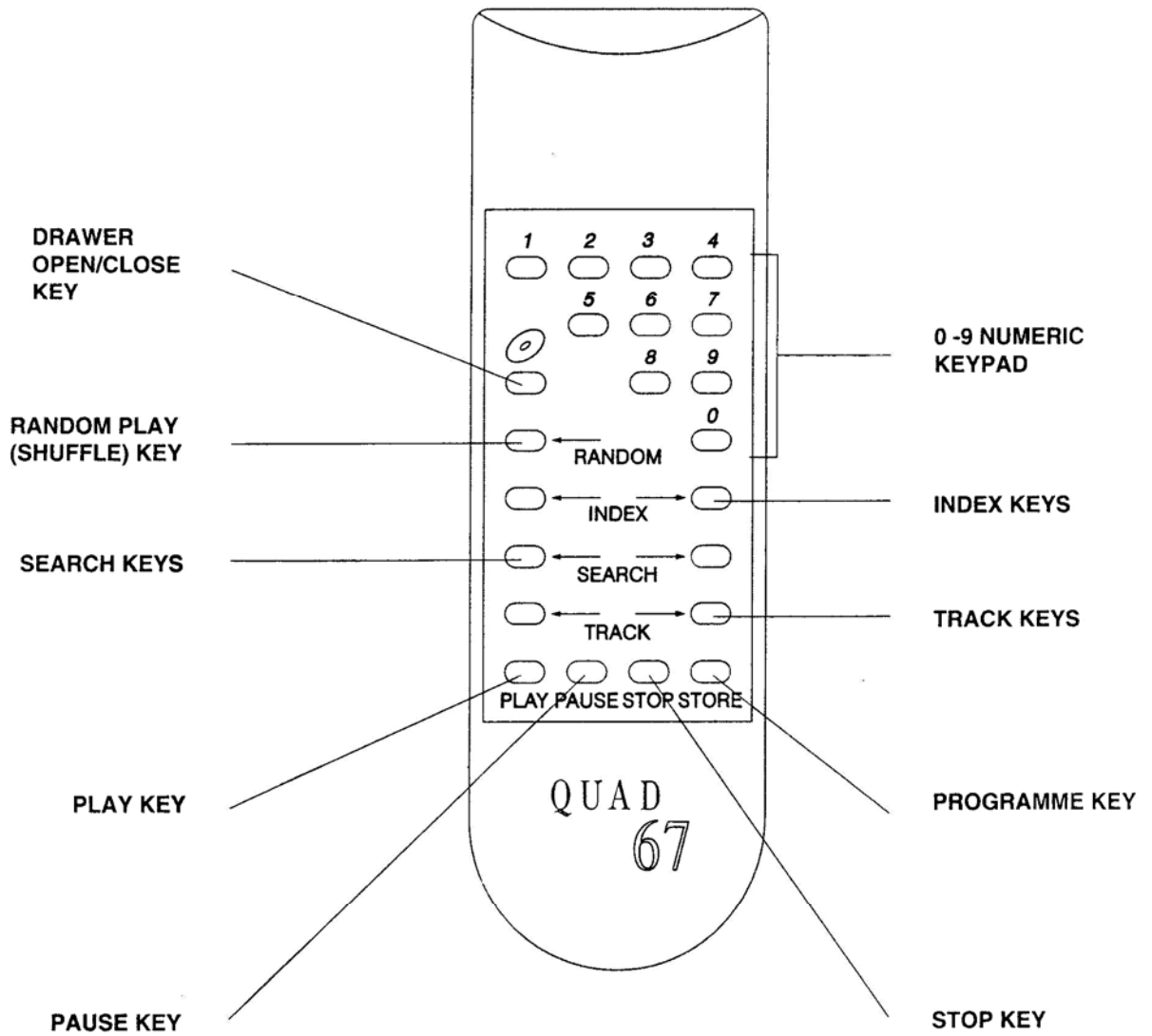

ACCESSORIES

Quad accessories are designed to match Quad equipment and to provide the best possible performance. Please contact your dealer or Quad direct for further information.

<i>Item</i>	<i>Order No</i>
Quad rack for: 66/67CD/66pre/66FM	QF6CDRK
Quad pedestal	QPEDASG
Signal lead Phono (0.5m)	QP2P2SA
Signal lead Phono (1m)	QP2P21A
AC interconnect supply lead Euro/Euro (0.45m)	QSPES5B
AC interconnect supply lead Euro/Euro (1m)	QSPES1B
AC supply lead Euro/free end (2m)	QESOE2A